



BILL40M



CONTROL PANELS:

BILL40M

BRAINY HEADY

p.112
p.113

AUTOMATIONS FOR SWINGING GATES LINEAR TELESCOPIC OPERATOR

personalised release key
up to 3.5 m



230 Vac

- Irreversible 230 Vac electromechanical geared motor with easy access release from above
- Neat design and size, particularly suited to forged iron gates
- Easy and quick to install due to compact size and installation dimensions

- Worm protected by a scraper ring and stainless steel stem, suitable for use in dusty and sandy environments or where there are aggressive atmospheric agents.
- Available in right or left version

MADE IN ITALY

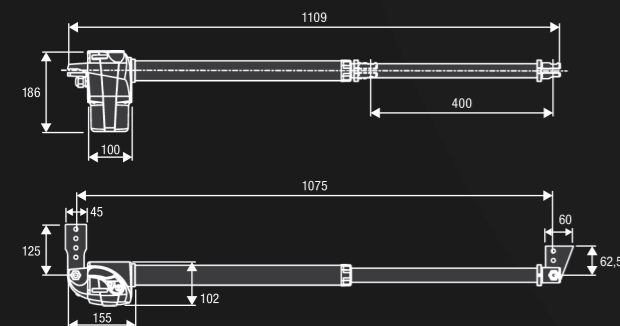

MEASURES



COMPLETE KITS

KBILL40M 9592188

2 **BILL40M** 230 Vac Operators

1 **HEADY** 230 Vac control unit with integrated receiver

1 **PUPILLA.F** Pair of photocells

1 **LAMPI.LED** 230 Vac Led flashing light with built-in aerial

1 **TOKEY** Metal key selector

1 **TO.GO2WV** 433.92 MHz Transmitter

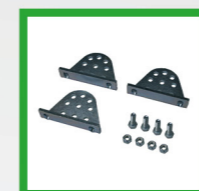

B.SR
9819310

Multiposition brackets for one operator BILL40M.

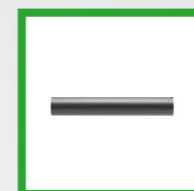

BILL40.CO
9253003

Telescopic stem cover accessory for models BILL40M.

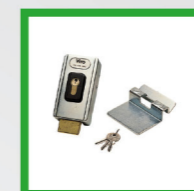

DU.V96
9765035

12 Vac/dc vertical electric lock, supplied with counterplate. Permits internal/external release.

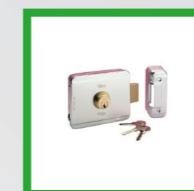

DU.V90
9765030

12 Vac/dc horizontal electric lock, supplied with counterplate. Permits internal/external release.



DU.9990
9623010

Covering plate for DU.V90.

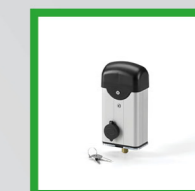

E.LOCK
9765001

230 Vac vertical electric lock, supplied with counterplate.



E.LOCKSE
9765002

Extended cylinder for E.LOCK electric lock. It allows to unlock gates up to 55mm-thick from the outside.



ID.TA
9846019

Warning board.



ESA BASIC
9176108

System that reduces the electrical energy consumption.

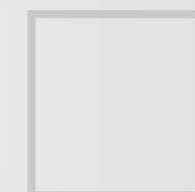
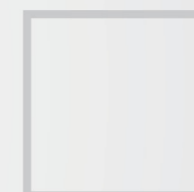
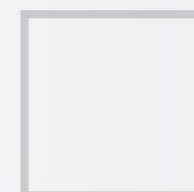
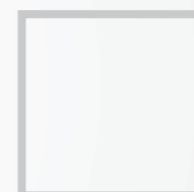

TECHNICAL DATA

	BILL40M
Code	9592124 (R) / 9592125 (L)
Power supply	230 Vac (50-60Hz)
Motor supply	230 Vac
Max absorbed current	1.1 A
Max Thrust	2800 N
Opening time	18"
Operation cycle	30%
Standard stroke	400 mm
Max stroke	420 mm
Protection level	IP54
Operating temperature	-20°C / +50°C
Leaf max dimension	3.5 m
Weight	6.0 kg
Items no. per pallet	60
Kits no. per pallet	21